

SPECIFICATIONS

Single Ended - G5.3

CROSS REFERENCE

LAMP DESCRIPTION ORDERING CODE

MANUFACTURER - LAMP # EQUIPMENT MODEL

EYH/FKT JCD120V-250WB 1000453

Watts	250W
Volts	120V
Color Temp	3050K
Approx Lumens	6050Lm
Average Life	150Hrs
Filament	CC-6
Burn Position	BD/Hor
Base	G5.3

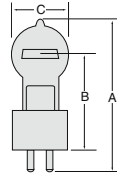

MOL (A)	63.5mm
Lighted Length (B)	36.5mm
Bulb Diameter (C)	22mm

NUARC - VE-980

FBG/FBD JCD120V-500WCP 1000476

Watts	500W
Volts	120V
Color Temp	3200K
Approx Lumens	13200Lm
Average Life	50Hrs
Filament	CC-6
Burn Position	BD/Hor
Base	G5.3

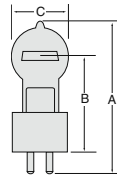

MOL (A)	76mm
Lighted Length (B)	44.5mm
Bulb Diameter (C)	22mm

ITEK - 192511-001
435 (bottom)

DYH JCD120V-600WCP 1000246

Watts	600W
Volts	120V
Color Temp	3200K
Approx Lumens	17000Lm
Average Life	75Hrs
Filament	CC-6
Burn Position	BD/Hor
Base	G5.3

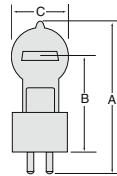

MOL (A)	63.5mm
Lighted Length (B)	36.5mm
Bulb Diameter (C)	22mm

ITEK - 192531-001
430 (top)
SMITH VICTOR
SV-403-004
SV-591; SV-592

DVY JCD120V-650WSP 1000225

Watts	650W
Volts	120V
Color Temp	3400K
Approx Lumens	20000Lm
Average Life	25Hrs
Filament	CC-6
Burn Position	BD/Hor
Base	G5.3

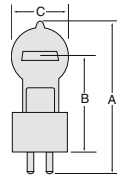

MOL (A)	63.5mm
Lighted Length (B)	36.5mm
Bulb Diameter (C)	22mm

ITEK - 198005-001
560
VISUAL GRAPHICS
62-12205-005

DYJ JCD230V-650WSP 1000247

Watts	650W
Volts	230V
Color Temp	3400K
Approx Lumens	20000Lm
Average Life	20Hrs
Filament	2CC-8
Burn Position	BD/Hor
Base	G5.3

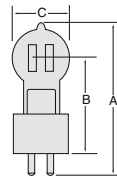

MOL (A)	63.5mm
Lighted Length (B)	42.9mm
Bulb Diameter (C)	24mm

SPECIFICATIONS

Single Ended - G6.35 GX6.35; GY6.35

CROSS REFERENCE

LAMP DESCRIPTION
ORDERING CODE

MANUFACTURER - LAMP #
EQUIPMENT MODEL #

BRL JC12V-50W
1000071

Watts 50W
Volts 12V
Color Temp 3300K
Approx Lumens 1400Lm
Average Life 50Hrs
Filament CBar6
Burn Position BD/Hor
Base G6.35

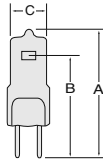

MOL (A) 44mm
Lighted Length (B) 30mm
Bulb Diameter (C) 11.5mm

DR. HELL
Scanner
SIEMENS

FDV JC24V-150W
1000505

Watts 150W
Volts 24V
Color Temp 3350K
Approx Lumens 4600Lm
Average Life 100Hrs
Filament CBar6
Burn Position BD/Hor
Base G6.35

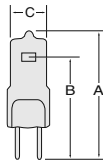

MOL (A) 50.8mm
Lighted Length (B) 30mm
Bulb Diameter (C) 14mm

SIMON OMEGA
471-027
VISUAL GRAPHICS
62-12205-003

EHI JC24V-250W
1000290

Watts 250W
Volts 24V
Color Temp 3400K
Approx Lumens 8500Lm
Average Life 50Hrs
Filament CBar6
Burn Position BD/Hor
Base G6.35

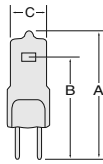

MOL (A) 55mm
Lighted Length (B) 33mm
Bulb Diameter (C) 13.5mm

JGV120V-1000WC4
1001822

Watts 1000W
Volts 120V
Color Temp 3200K
Approx Lumens 27000Lm
Average Life 100Hrs
Filament 2CC-8
Burn Position BD/Hor
Base GX6.35

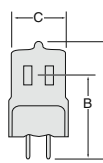

MOL (A) 67.5mm
Lighted Length (B) 38mm
Bulb Diameter (C) 23mm

OLEC - L1KS
AL1KT; AL11KT;
ALKT

EVA JC12V-100H20
1000381

Watts 100W
Volts 12V
Color Temp 3000K
Approx Lumens 2000Lm
Average Life 2000Hrs
Filament CBar6
Burn Position BD/Hor
Base GY6.35

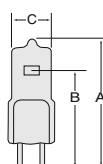

MOL (A) 44mm
Lighted Length (B) 30mm
Bulb Diameter (C) 11.5mm

OLEC - L1CP
AL1CP; AL1CX

Single Ended - G9.5; GY9.5

SPECIFICATIONS

LAMP DESCRIPTION ORDERING CODE

CROSS REFERENCE

MANUFACTURER - LAMP # EQUIPMENT MODEL

FEL JCV120V-1000WCH 1000509

Watts	1000W
Volts	120V
Color Temp	3200K
Average Life	375Hrs
Approx Lumens	27500Lm
Filament	CC-8
Burn Position	Any
Base	G9.5

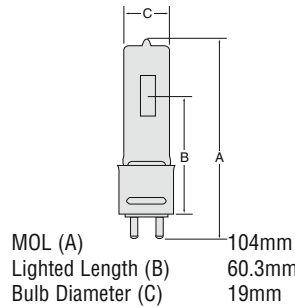

SCREEN USA (DS AMERICA)
Camera
NUARC

JCD120V-300WC 1000896

Watts	300W
Volts	120V
Color Temp	3200K
Average Life	100Hrs
Approx Lumens	7500Lm
Filament	CC-6
Burn Position	BD/Hor
Base	GY9.5

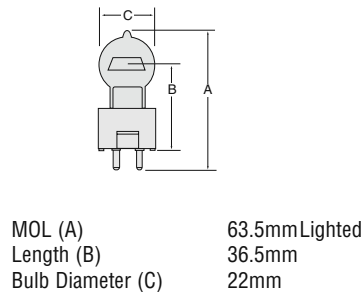

BENCHER

DYS JCD120V-600WC 1000251

Watts	600W
Volts	120V
Color Temp	3200K
Average Life	75Hrs
Approx Lumens	17000Lm
Filament	CC-6
Burn Position	BD/Hor
Base	GY9.5

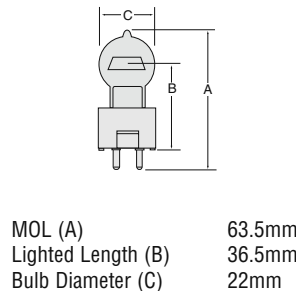

DYR/220V JCD220V-650WC1 1000249

Watts	650W
Volts	220V
Color Temp	3200K
Average Life	50Hrs
Approx Lumens	16500Lm
Filament	2CC-8
Burn Position	BD/Hor
Base	GY9.5

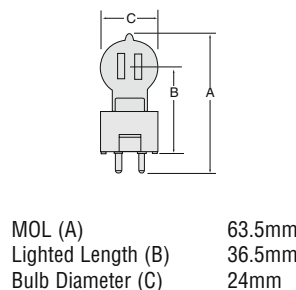

ITEK - 197632-001
560

DYR/240V JCD240V-650WC2 1000250

Watts	650W
Volts	240V
Color Temp	3200K
Average Life	50Hrs
Approx Lumens	16500Lm
Filament	2CC-8
Burn Position	BD/Hor
Base	GY9.5

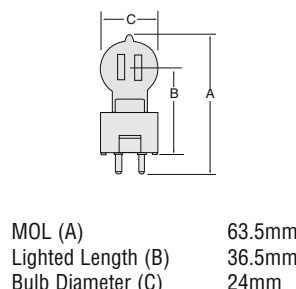

ITEK - 197632-001
560

SPECIFICATIONS

Single Ended - G17t-7 BA15d, BA15s; E11

CROSS REFERENCE

LAMP DESCRIPTION
ORDERING CODE

MANUFACTURER - LAMP #
EQUIPMENT MODEL #

BCK INC120V-500W
1000047

Watts	500W
Volts	120V
Color Temp	3250K
Average Life	50Hrs
Filament	C-13D
Burn Position	BD/Hor
Base	G17t-7

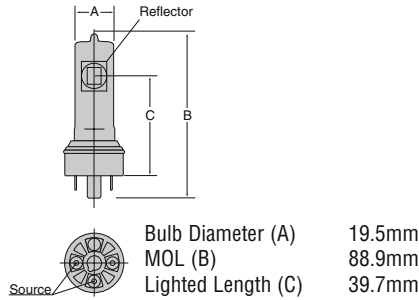

VISUAL GRAPHICS
62-12205-002

ETB JCV120V-250WGBF
1000372

Watts	250W
Volts	120V
Color Temp	3000K
Average Life	2000Hrs
Approx Lumens	4800Lm
Filament	CC-8
Bulb Finish	Frosted
Burn Position	Any
Base	BA15d

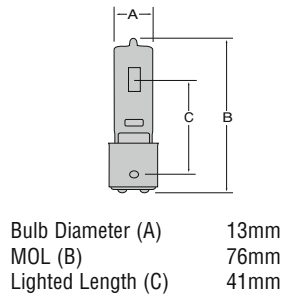

KENRO - 532-0025
2600

SM-100T8/1SC
8000044

Watts	100W
Volts	20V
Color Temp	3300K
Average Life	50Hrs
Approx Lumens	3050Lm
Filament	CC-6
Bulb Finish	Clear
Burn Position	Any
Base	BA15s

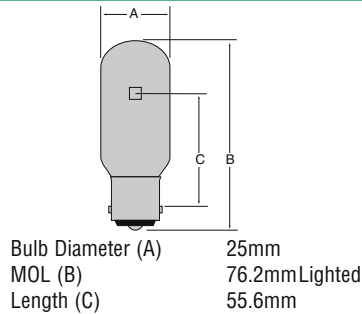

NUARC - VE66

JCV100V-200WGS
1001800

Watts	200W
Volts	100V
Color Temp	2900K
Average Life	2000Hrs
Approx Lumens	2900Lm
Filament	CC-8
Burn Position	Any
Base	E11

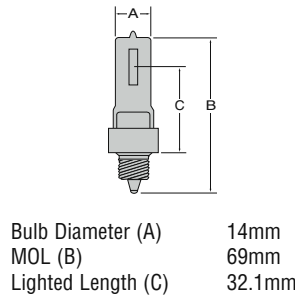

MITSUBISHI
CP-100 Platemaker